

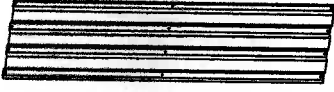

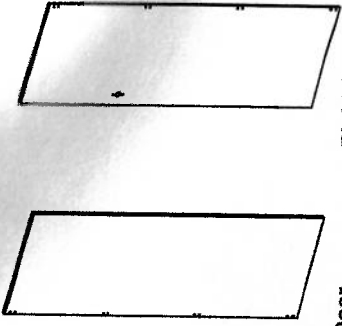

H1850mm*W1950mm*D1230mm

| | | | |
|--|---------------|---|---------------|
|  | A 6PCS |  | D 2PCS |
|  | B 5PCS |  | E 6PCS |
|  | C 2PCS |  | F 4PCS |

| | | | | | | | |
|------------|---|------------|---|------------|--|------------|---|
| A-G |  | A-H |  | A-I |  | A-J |  |
| | 4PCS | | 2PCS | | 1PC | | 1PC |

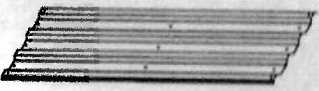
A-O

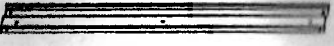
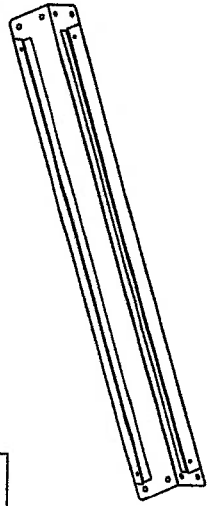
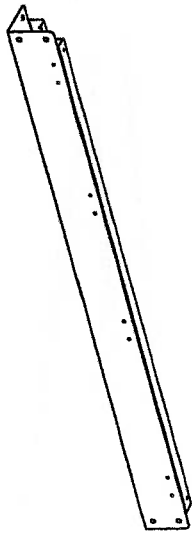
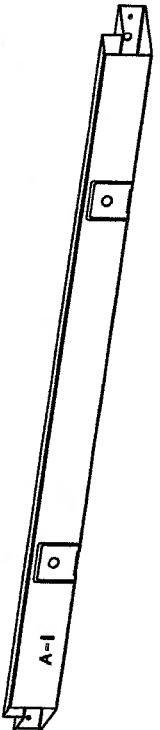
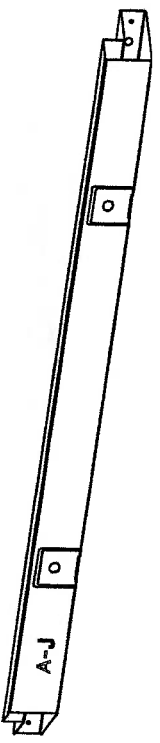
1PC

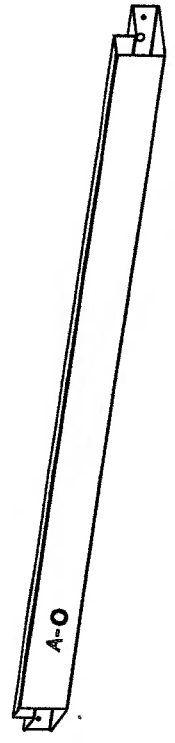

A-P

1PC

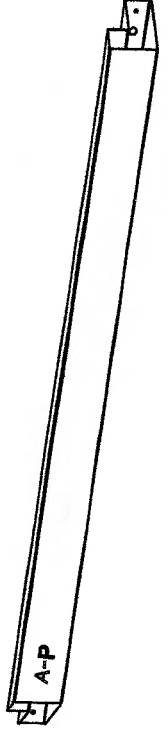

A-Q

2PCS

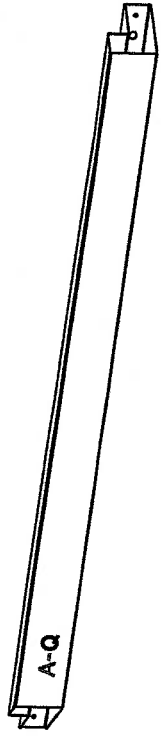

A-R

4PCS

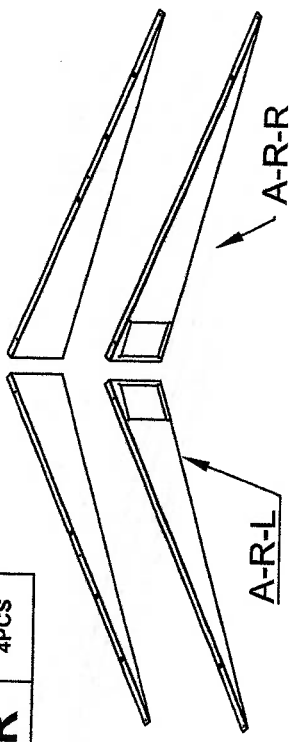

A-K

2PCS

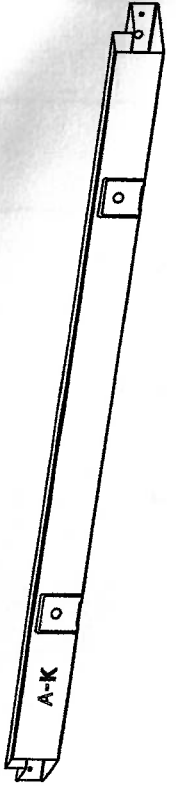

A-L

2PCS



A-M

2PCS

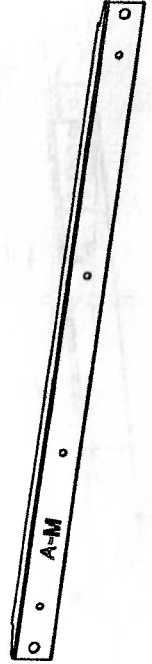





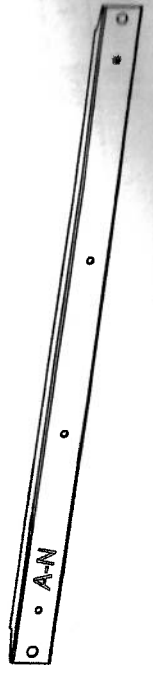

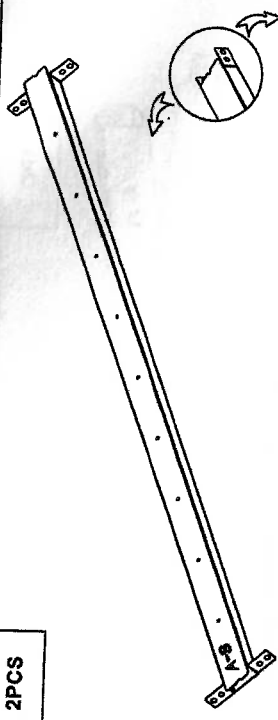
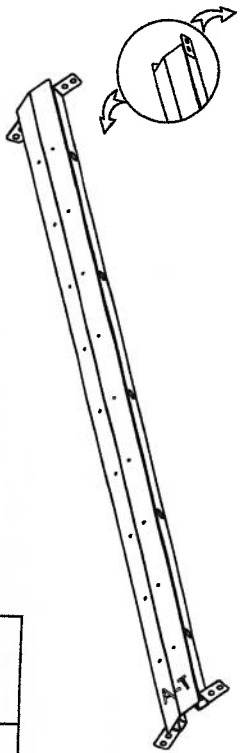
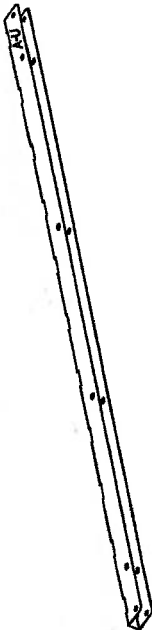
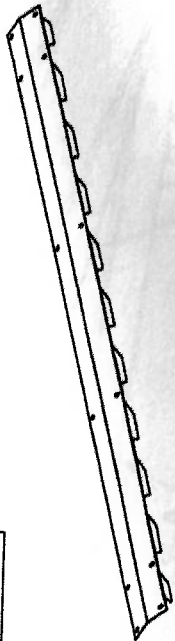

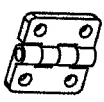
A-N

1PC

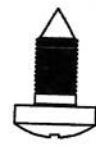

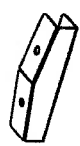
| | | |
|------------|------|---|
| A-S | 2PCS |  |
| A-T | 1PC |  |
| A-U | 2PCS |  |
| A-V | 1PC |  |

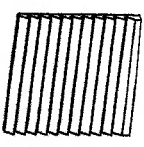
| | | |
|----------|----------------|---|
| f | 1PC |  |
| X | 8PCS |  |
| h | 32PCS M4*10 |  |
| b | 377PCS |  |
| Y | 1PC |  |
| c | 8PCS |  |
| Z | 2PCS |  |
| d | 1PC |  |
| a | 2PC |  |
| e | 90PCS |  |
| m | 2PCS |  |

Step 1

b



20PCS

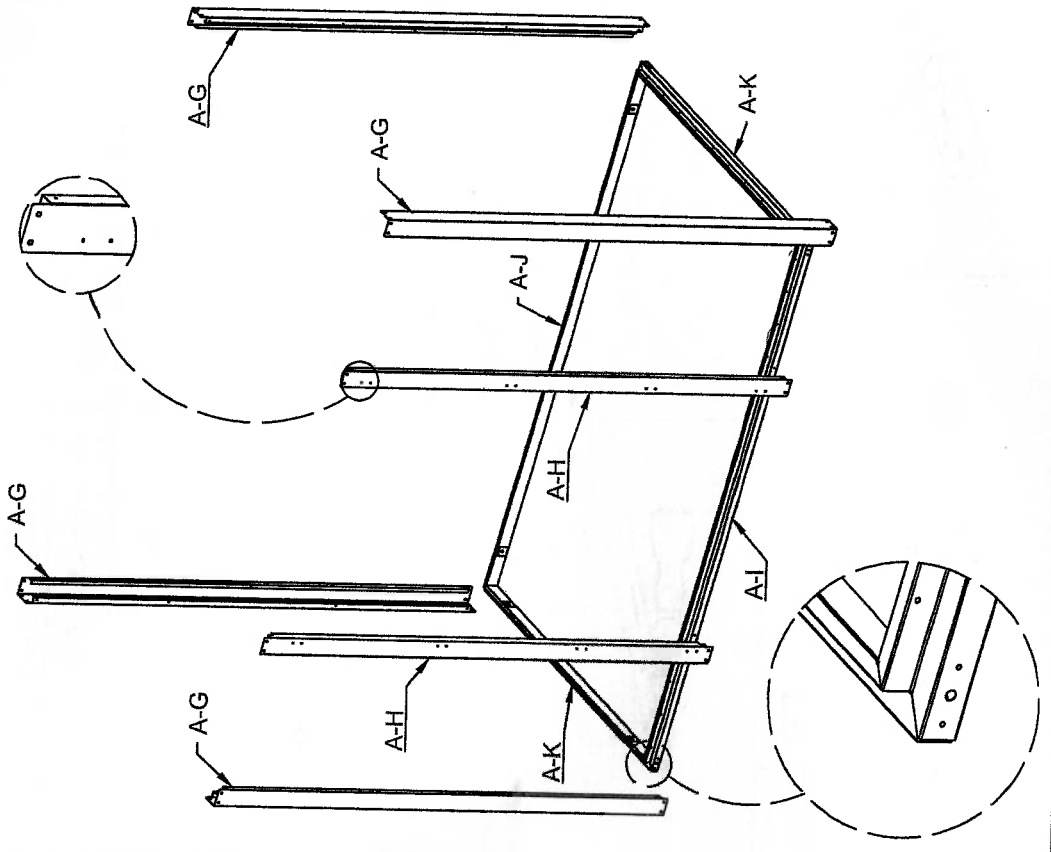

Step 2

b



10PCS

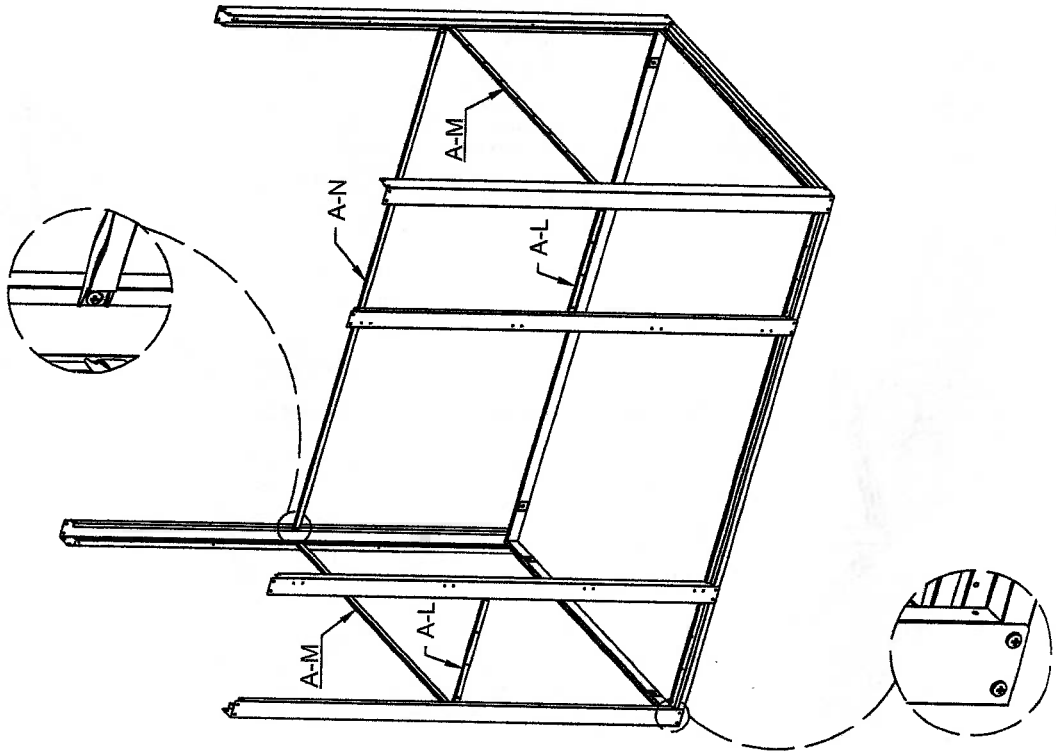

Step 3

b



20PCS

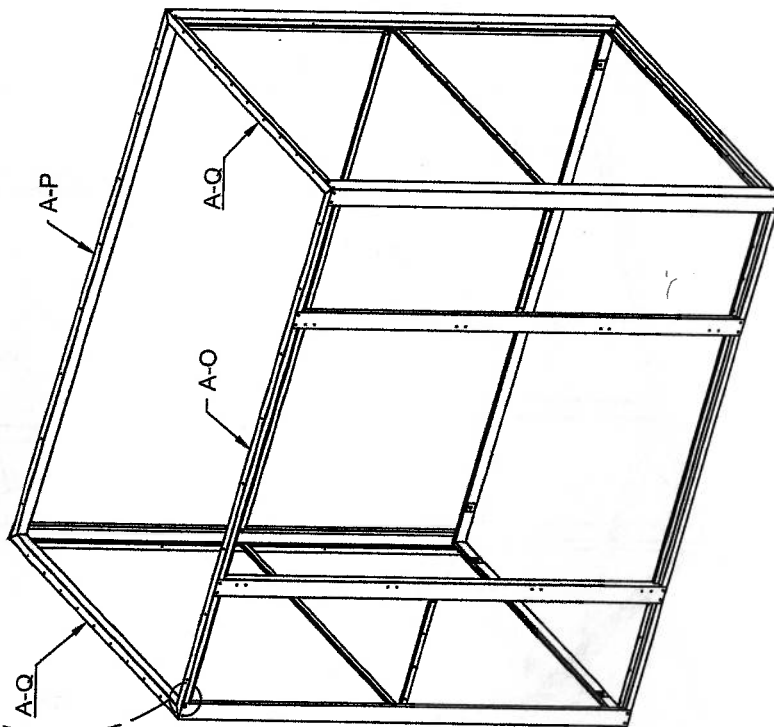
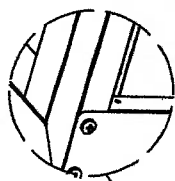

Step 4

Y

1PC

Z

2PCS

Right Door

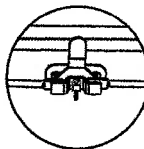
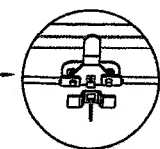
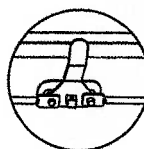
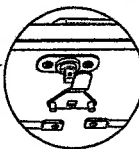
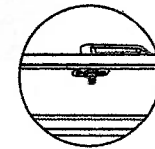
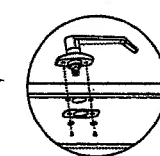
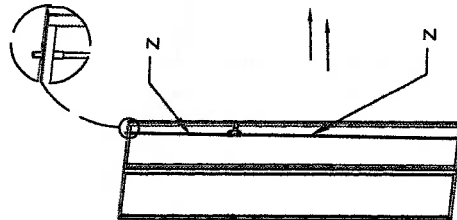
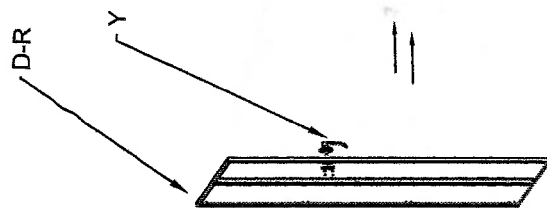

Step 5

b

5PCS



left Door

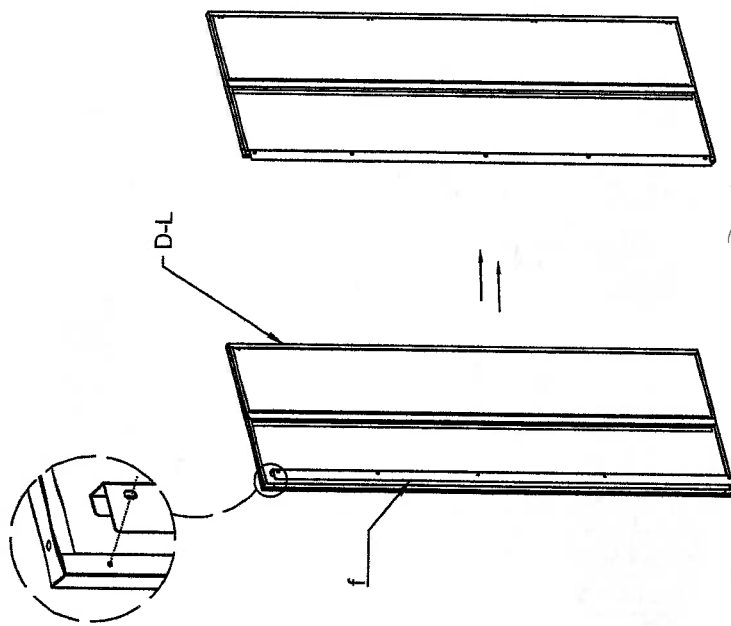

Step 6

h

M4*10

16PCS



X*4

X*4

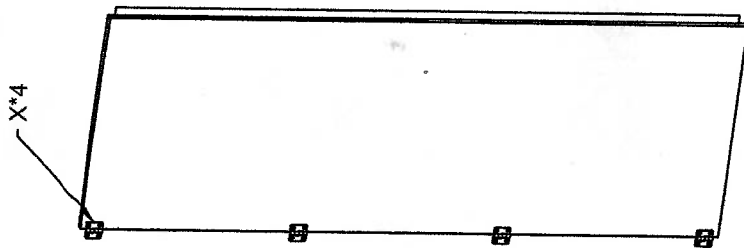

left Door

Right Door

Step 7

h

M4*10



16PCS

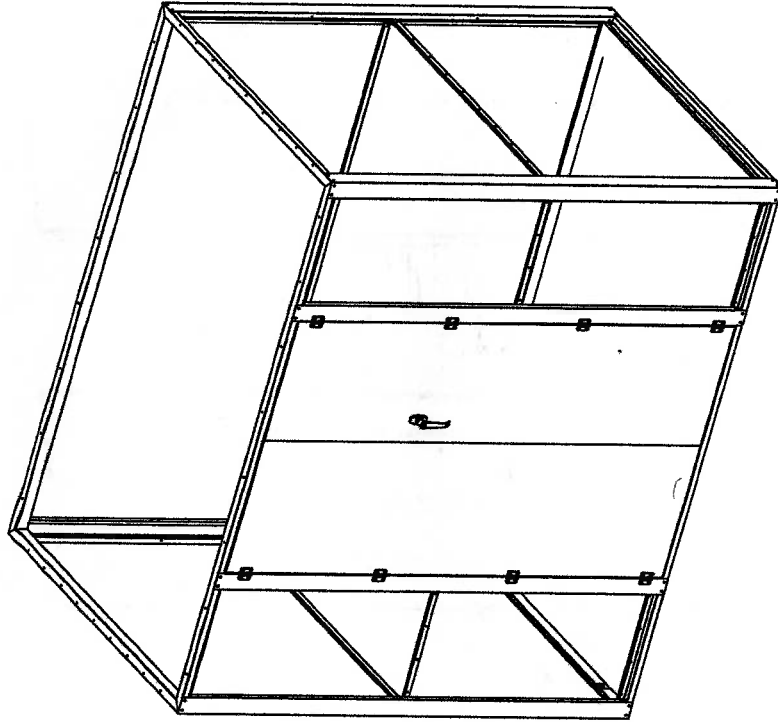

Step 8

b



48PCS

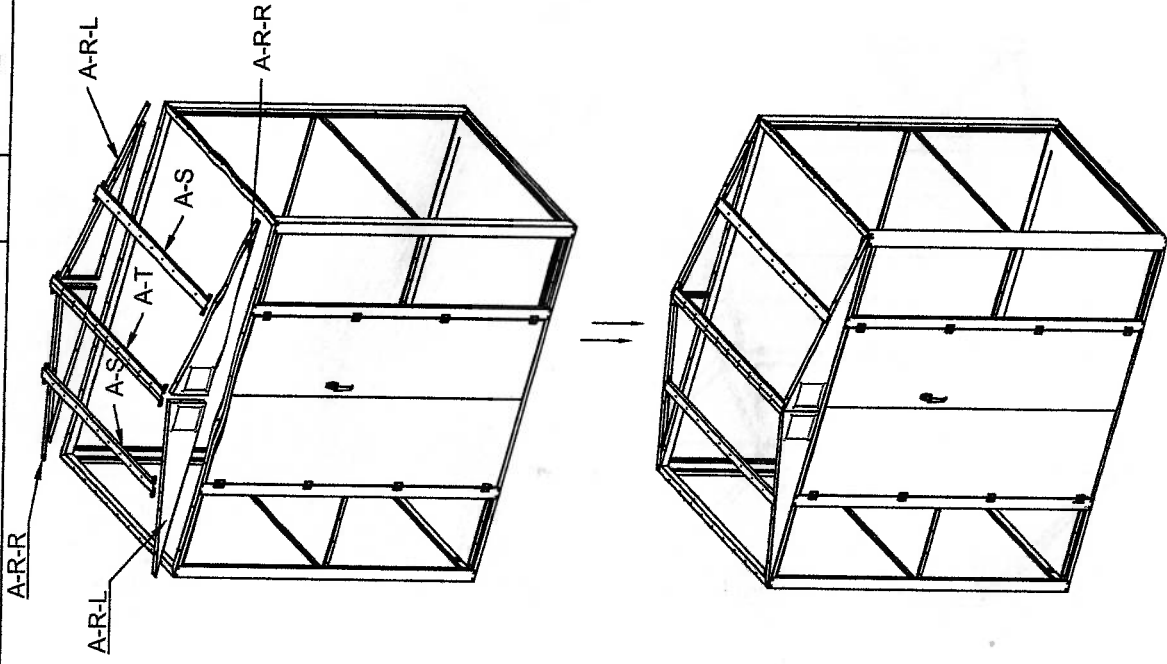

Step 9

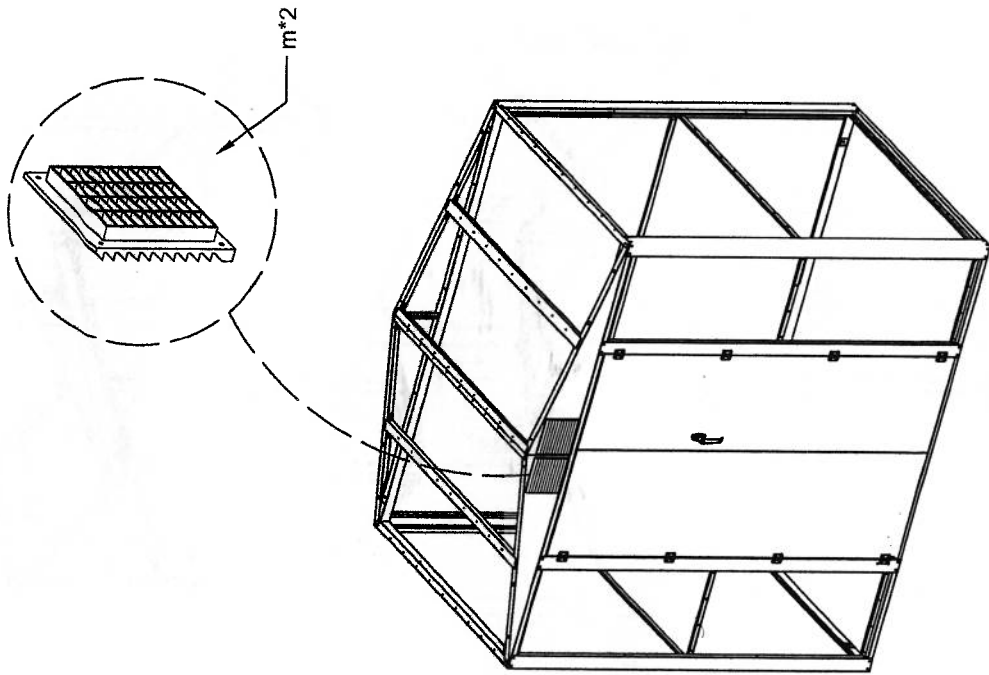

Step 10

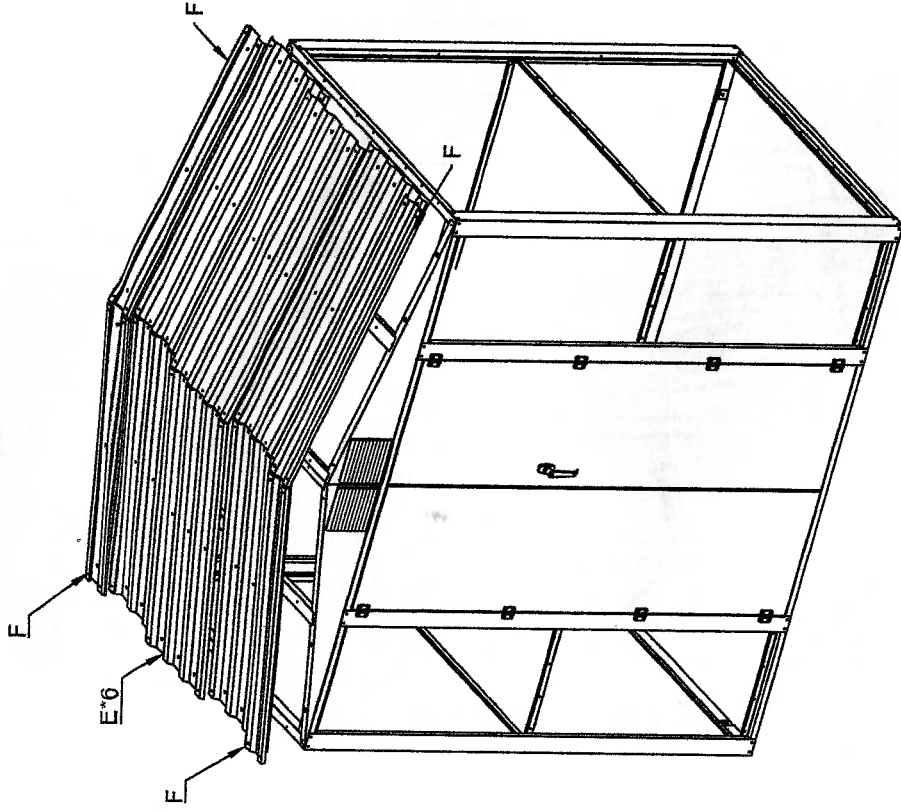

b



66PCS

e



66PCS

Step 11

b



24PCS

e



24PCS

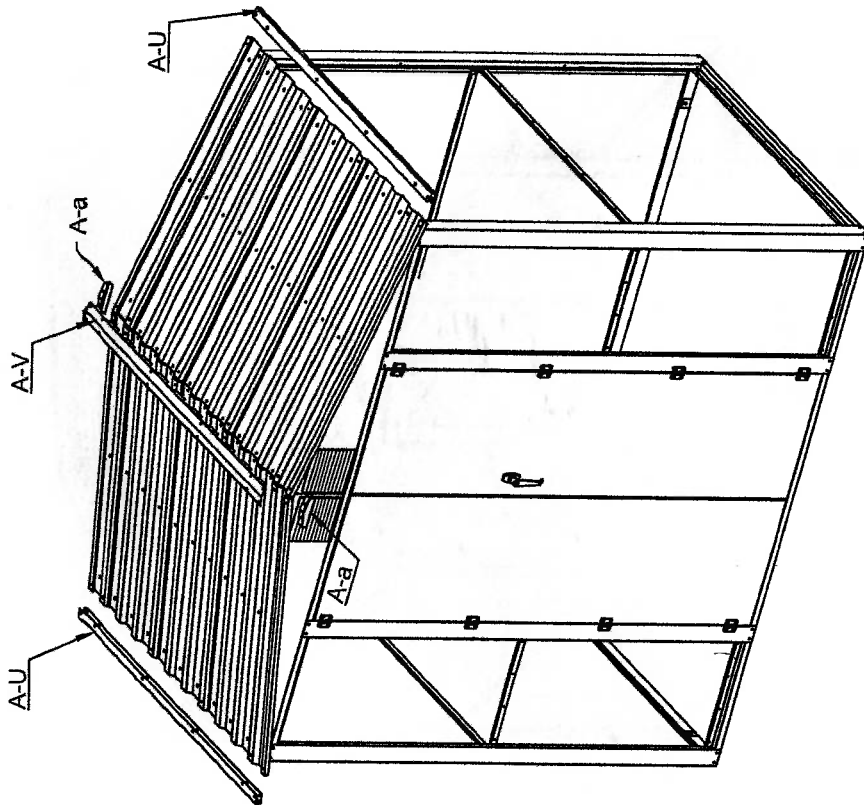

Step 12

b



118PCS

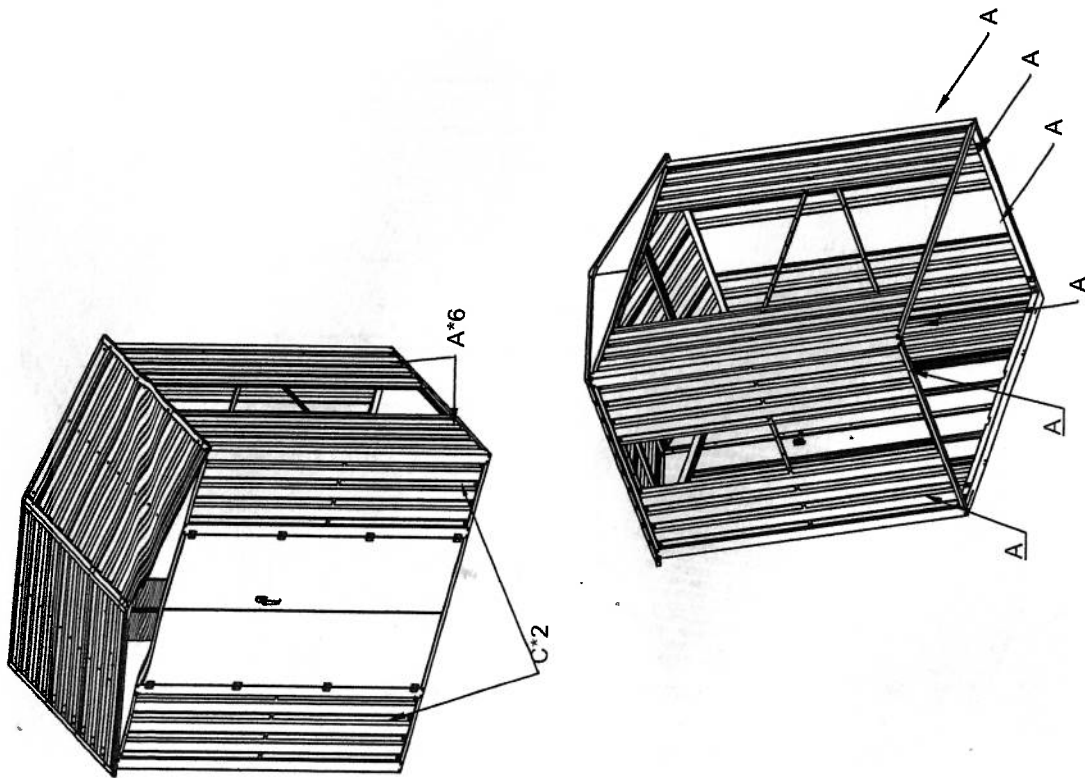

Step 13

b



54CS

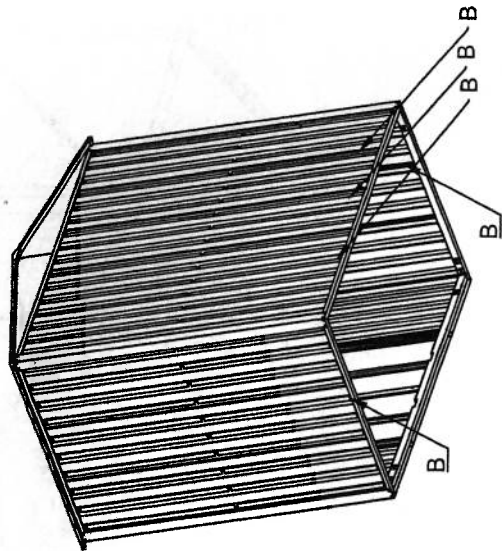
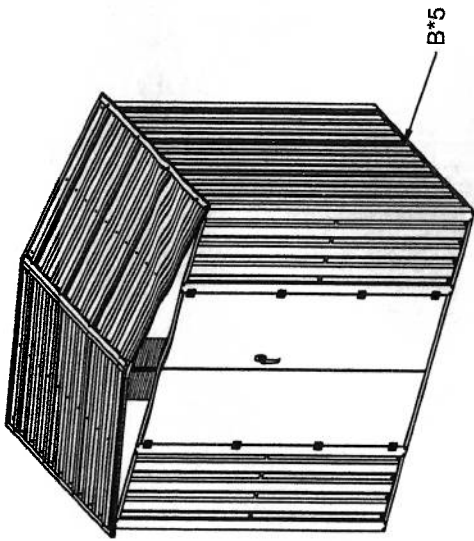







Step 14

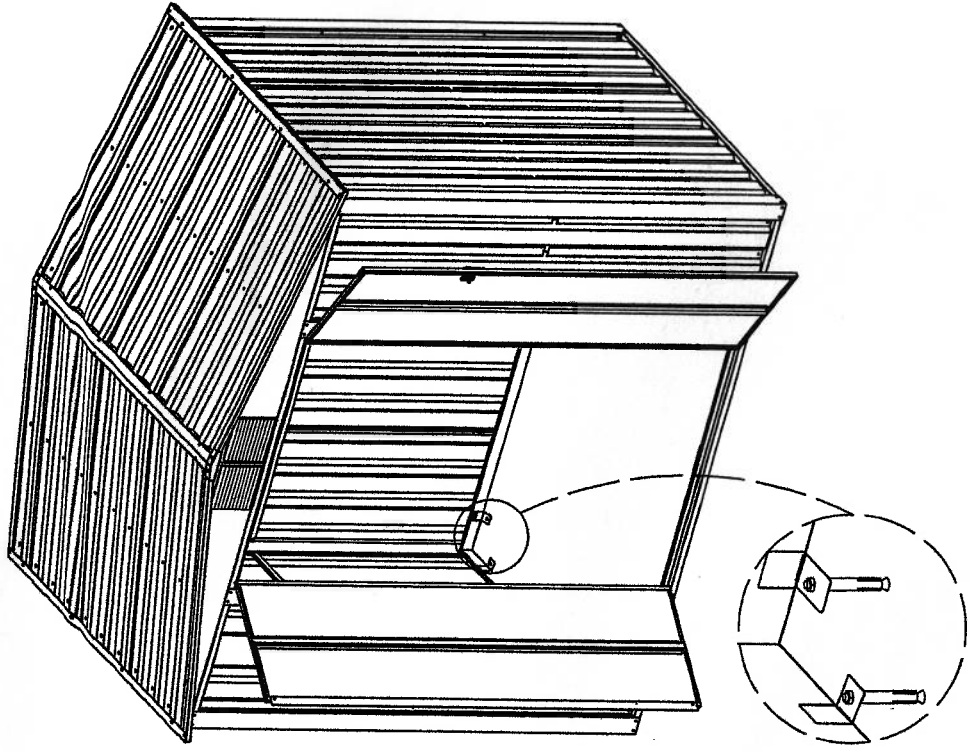



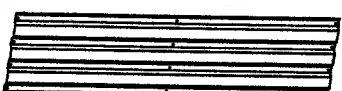

C

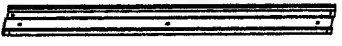

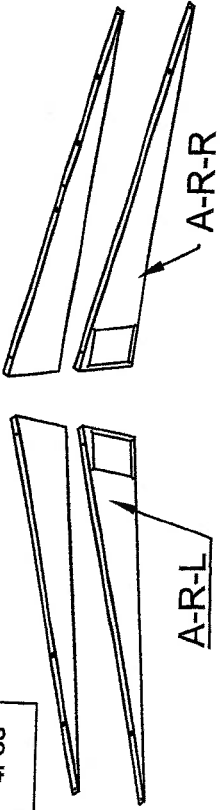
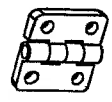



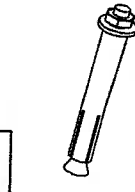

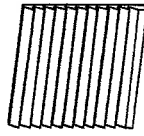

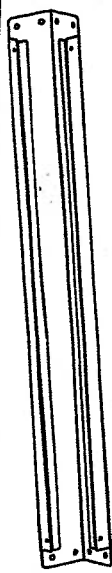



8PCS



| | | | |
|--|---------------|--|----------------------------|
|  | A 6PCS |   | Left Door D 2PCS |
|  | B 5PCS |  | E 6PCS |
|  | C 2PCS |  | F 4PCS |

| | |
|-------------------------|--|
| R 4PCS |  |
| X 8PCS |  |
| Y 1PC |  |
| Z 2PCS |  |
| a 2PCS |  |
| h 32PCS M4*10 |  |
| C 8PCS |  |
| d 1PC |  |
| e 90PCS |  |
| m 2PCS |  |

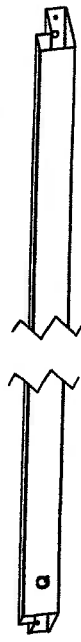
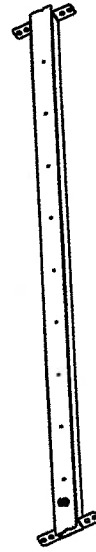
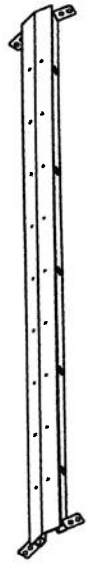
| | | |
|----------|------|---|
| G | 4PCS |  |
| H | 2PCS |  |
| I | 1PC |  |
| J | 1PC |  |
| K | 2PCS |  |
| L | 2PCS |  |
| M | 2PCS |  |
| N | 1PC |  |

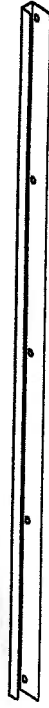
| | | |
|----------|------|---|
| O | 1PC |  |
| P | 1PC |  |
| Q | 2PCS |  |
| S | 2PCS |  |
| T | 1PC |  |
| U | 2PCS |  |
| V | 1PC |  |
| f | 1PC |  |